

Living up to Life

Leica

MICROSYSTEMS

A top-down view of the Leica TL5000 Ergo Transmitted Light Base. The device is white with a central circular opening for a microscope. On the left side, there are three control buttons labeled 'BF', 'RC', and 'DF'. On the right side, there is a small circular button. The device is mounted on a white base.

User Manual

Leica TL5000 Ergo Transmitted Light Base

General Notes

Safety concept

Before using your microscope for the first time, please read the "Safety concept" brochure included with your instrument. It contains additional information about handling and care.



Use in clean rooms

The Leica TL5000 Ergo can be used in clean rooms without any problems.

Cleaning

- ▶ You can find notes on cleaning in the appendix, which begins on page [53](#).

Servicing

- ▶ Repairs may only be carried out by Leica Microsystems-trained service technicians. Only original Leica Microsystems spare parts may be used.

Responsibilities of person in charge of instrument

- ▶ Ensure that the Leica stereomicroscope is operated, maintained and repaired by authorized and trained personnel only.

Symbols Used

Warning! Safety hazard!



This symbol indicates especially important information that is mandatory to read and observe.

Failure to comply can cause the following:

- ▶ Hazards to personnel
- ▶ Functional disturbances or damaged instruments

Warning of hazardous electrical voltage



This symbol indicates especially important information that is mandatory to read and observe.

Failure to comply can cause the following:

- ▶ Hazards to personnel
- ▶ Functional disturbances or damaged instruments

Important information



This symbol indicates additional information or explanations that are intended to provide clarity.

Explanatory notes

- ▶ This symbol within the text stands for additional information and explanations.

Figures

- (1) Numbers in parentheses within the descriptions relate to the figures and the items within those figures.

Safety Instructions

Description

The safety instructions in this manual refer to the installation and use of the Leica TL5000 Ergo transmitted light base. Be sure to read the safety instructions noted in the manual for your Leica stereomicroscope before use.

Intended use

- ▶ Refer to "Safety Concept" booklet

Non-intended use

- ▶ Refer to "Safety Concept" booklet

The instruments and accessories described in this User Manual have been tested for safety and potential hazards. The responsible Leica affiliate must be consulted whenever the instrument is altered, modified or used in conjunction with non-Leica components that are outside of the scope of this manual!

Unauthorized alterations to the instrument or noncompliant use shall void all rights to any warranty claims!

Place of use

- ▶ Refer to "Safety Concept" booklet
- ▶ Electrical components must be placed at least 10 cm away from the wall and from flammable substances.

Safety Instructions (continued)

Responsibilities of person in charge of instrument

- ▶ Refer to "Safety Concept" booklet

Ensure that:

- ▶ the base, the M series stereomicroscopes and accessories are operated, maintained and repaired by authorized and trained personnel only.
- ▶ All operators have read, understood and observe this User Manual, and particularly the safety instructions.

Repairs, service work

- ▶ Refer to "Safety Concept" booklet
- ▶ Only original Leica Microsystems spare parts may be used.
- ▶ Before opening the instruments, switch off the power and unplug the power cable.



Touching the live circuit can cause injury.

Integration in third-party products

- ▶ Refer to "Safety Concept" booklet

Disposal

- ▶ Refer to "Safety Concept" booklet

Legal regulations

- ▶ Refer to "Safety Concept" booklet

EC Declaration of Conformity

- ▶ Refer to "Safety Concept" booklet

Contents

Leica TL5000 Ergo	
Congratulations!	8
The Modular Design: Everything is Relative	9
On We Go	10

Assembly	
Important Information for Assembly	12
Assembling the Focusing Column	13
Motorized Focus: Restricting the Travel Path	14
Optics carrier	15
Tube	16
Eyepieces	17
Objective	18

Quick Start Guide	
An overview of the Leica TL5000 Ergo	20
The integrated aperture	21
The different contrast methods	22
Possible scenarios	23
Switching the transmitted light base on and off	24
Working with bright field illumination	26
Working with Rottermann contrast	27
Working with dark field illumination	29
Dark field for fluorescence applications	30
Switching the automatic control system for bright field on and off	31
Resetting the base to factory default settings	32

Preparation for the automatic control system	
The basics	34
Detection with SmartTouch™	35
Detection with Leica Application Suite	36
Detection with Leica Application Suite AF	37

Operation with Leica SmartTouch™	
Leica SmartTouch™ expands your possibilities!	39
An overview of the Leica SmartTouch™	40
Controls on the Touchscreen	41
Accessing the Leica TL5000 Ergo	42
Bright field illumination control system	43
Rottermann contrast control system	44
Dark field illumination control system	45
Switching off the LED display	46
Resetting settings	47
Malfunction indicator / automatic shutoff	48

Dimensions and Specifications	
Dimensions	50
Specifications	51

Appendix	
Care, Maintenance, Contact Persons	53

Leica TL5000 Ergo

Congratulations!

Congratulations on purchasing your new Leica TL5000 Ergo transmitted light base. The multitude of contrast methods will make your daily work substantially easier. Whether bright field, dark field or Rottermann contrast: The optimal illumination for your specimens is always available while you work. The transmitted light base is maintenance-free due to the energy saving, long-lasting LED light source; lamp replacements are a thing of the past.

Furthermore, the Leica TL5000 Ergo fits seamlessly with the encoded components of the Leica M series. If, for example, you work with an encoded Leica M205 C stereomicroscope, the information on magnification or objectives in use is automatically relayed to your Leica TL5000 Ergo transmitted light base or Leica SmartTouch™ control unit.

Though the reliability and robustness of Leica devices is world-renowned, the Leica TL5000 Ergo requires a certain degree of care and attention. Therefore, we recommend that you read this manual. It contains all the information you need regarding operation, safety and maintenance. Simply observing a few guidelines will ensure that even after years of intensive use, your transmitted light base will continue to work as smoothly and reliably as on the very first day.

We wish you the best of success in your work!

The Modular Design: Everything is Relative

The Leica M series provides maximum flexibility in choosing equipment, thanks primarily to the modular configuration and the compatibility that Leica has painstakingly maintained for decades. The optics carriers, eyepieces, bases and more can be combined in any way you choose, allowing you to create the microscope that best suits your needs.

Despite this, you will notice that the control elements and individual components do not differ significantly. Whichever configuration you choose, you will quickly feel right at home.

Have a special request? Let us know!

Leica Microsystems enjoys an exceptional reputation when it comes to devising customer-specific solutions. If you have a special request that cannot be met with standard parts, contact your Leica consultant. We have a solution for every problem.

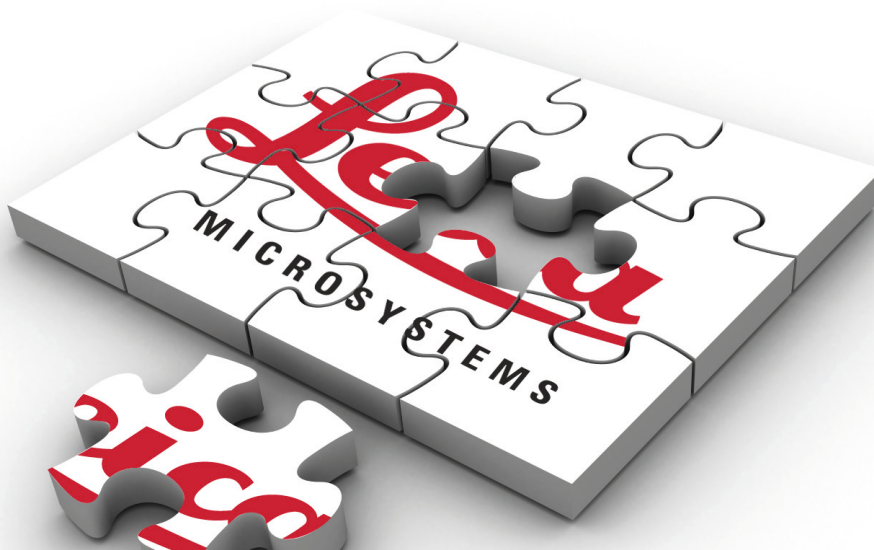

On We Go

If your new equipment configuration has already been assembled and commissioned by your Leica consultant, skip the installation instructions and start with the Quick Start Guide on page 19.



If, on the other hand, you are putting the base and microscope together yourself, continue with the "Assembly" chapter, which begins on page 11

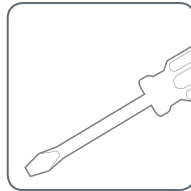

Assembly

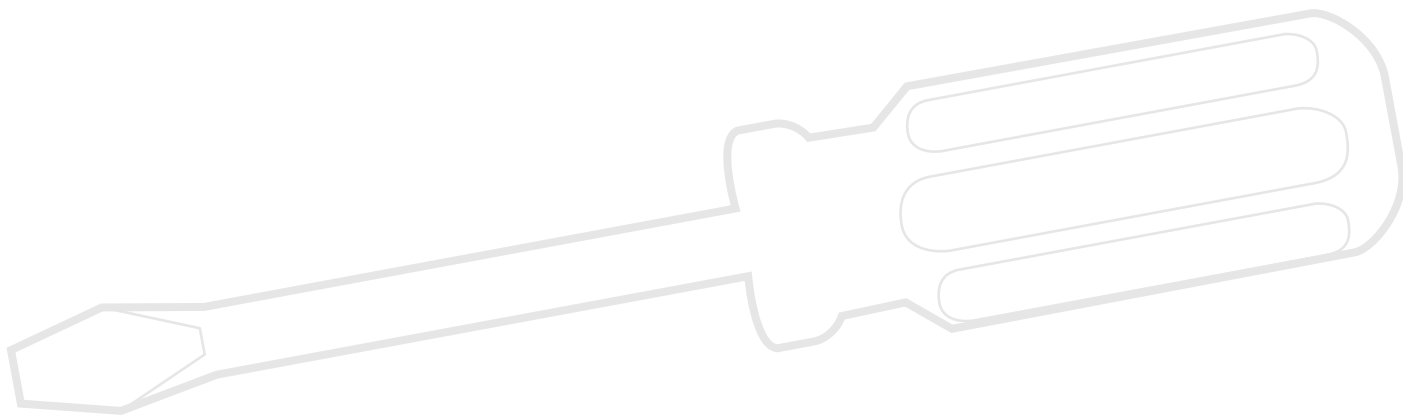

Important Information for Assembly



The following instructions refer to the assembly of the Leica TL5000 Ergo transmitted light base together with the Leica M205 C stereomicroscope. However, the transmitted light base can be operated with all Leica M series stereomicroscopes – with or without fluorescence. For details on assembling the optics carrier, tube, and eyepieces please consult your stereomicroscope's user manual.

Assembling the focusing column

The first step is to connect the focusing column of the M series to the Leica TL5000 Ergo.

Tools used

- ▶ Hex socket screwdriver, 3 mm

Assembling the column adapter

1. Securely install the column adapter on the column using the four included screws.



Assembling the focusing column

2. Securely screw the focusing column to the Leica TL5000 Ergo using the 6 included screws.



Motorized Focus: Restricting the Travel Path



Depending on the work situation, it may be necessary to restrict the maximum travel path of the stereomicroscope. This prevents the following:

- ▶ Injuries when manipulating the specimen because the fingers or hand get pinched.
- ▶ Accidental contact between the objective and the specimen, and potential resulting damage.

Readjusting the motorized focus

The motorized focus is factory-adjusted and normally does not need to be readjusted – even if the maximum travel path is changed.

Exception: If the power fails while the motorized focus is moving, the position data are lost. In this case, the calibration must be repeated using the Leica LAS software or the Leica SmartTouch™. To do so, please consult the respective manual.

Restricting the bottom travel range

1. Move the motorized focus into the lowest position you want to reach.
2. Unscrew the screw of the limit stop on the side of the focusing column.

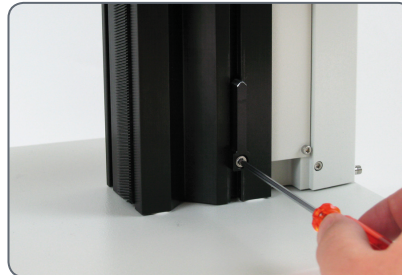

3. Push the limit stop to the height of the motorized focus.

It is easiest to move the limit stop by keeping the screwdriver inserted and moving it upwards.

4. Tighten the screw of the limit stop.

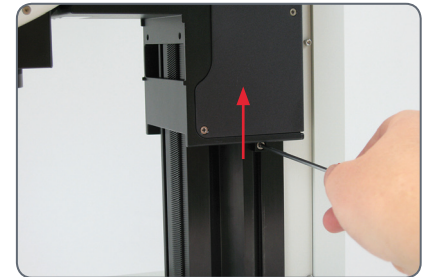

Optics Carrier

Tools used

- ▶ Hex socket screwdriver, 4 mm

 Please use the planapochromatic objectives of the M series (article numbers 10 450 027 to 10 450 030) with the microscope carrier. If you have any inquiries regarding compatibility and adaptation of other models, please contact your Leica consultant.

Assembling the Optics Carrier

1. Place the microscope carrier on the focusing column so that the screw fits into the thread provided and the lug fits into the groove.



2. Press the microscope carrier backwards to the focusing column and screw it in place using your other hand.



3. Insert the optics carrier into the microscope carrier and fasten it with the locking screw.



Tube

 All intermediate tubes that fit between the optics carrier and the binocular tube are fitted in the same manner.

 Please note that inserting intermediate elements can lead to shading in the border area of the field of view.

Preparations

1. Unscrew the positioning screw and remove the protective cover.

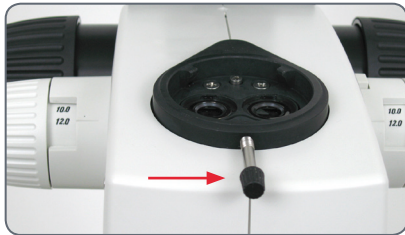

Assembling the tube

2. Push the tube (for example, the inclined binocular tube) into the dovetail ring and rotate it slightly in both directions until the positioning screw meshes with the guide groove.
3. While holding the tube only slightly, carefully tighten the positioning screw. It is automatically brought to the correct position.

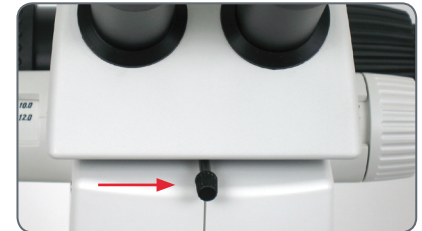

Eyepieces

Tools used

- ▶ No tools required.

Magnification range

You can extend the overall magnification range using available 10×, 16×, 25× and 40× wide-field eyepieces for persons wearing glasses.

Preparation

1. If you want to use an optional reticule, insert it now.
2. Remove the plastic tube guard.



Inserting the eyepieces

3. Push the eyepieces into the tubes as far as they will go and check to ensure that they fit tightly and accurately.



4. Securely tighten the clamping screws.



Objective

Tools used

- ▶ No tools required.

Hold the objective firmly during assembly and disassembly so that it does not fall onto the stage plate. This applies particularly to the 2x planapochromatic objective, which is very heavy. Remove all specimens from the stage plate first.

Attaching the objective

1. Remove the protective cover on the optics carrier.

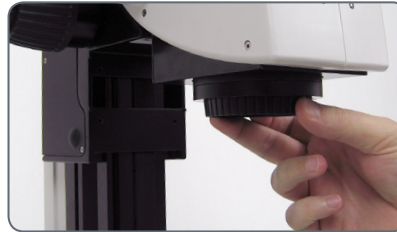

2. Screw the objective clockwise into the optics carrier.



Quick Start Guide



An Overview of the Leica TL5000 Ergo

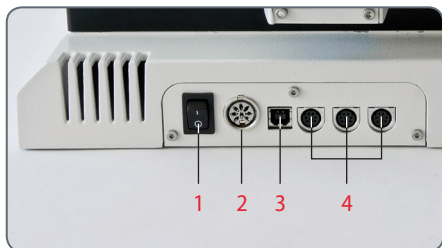

Back panel

- 1 Power switch for the base
- 2 Power connection
- 3 1 × USB port
- 4 3 × CAN bus port



Left side

- 1 LED display for opening and positioning the aperture or for balance in DF mode.
- 2 Control for the size of the aperture/balance
- 3 "BF" button for bright field (press and hold for 2 seconds to (de)activate the automatic aperture)
- 4 "RC" button for Rottermann Contrast / in the RC mode, press and hold the button to define the aperture size
- 5 "DF" button for dark field



Right side

- 1 On/Off switch for the light source / Press and hold for 5 seconds to reset the base to factory default settings
- 2 Controls for controlling the brightness intensity

The integrated aperture

The integrated aperture

i The Leica TL5000 Ergo possesses an integrated aperture, with which the illuminated field and illumination angle can be adjusted. This way the aperture automatically opens for bright field exposures at low magnifications; on the other hand, at higher magnifications it closes.

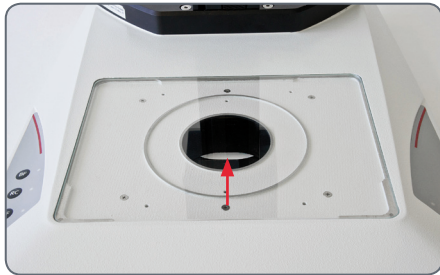

i The respective opening of the aperture influences the area of illumination as well as the light guide. A large aperture leads to scattered, soft light; on the other hand, a smaller aperture leads to a defined, intensive light source.

i If the Leica TL5000 Ergo is used with an encoded stereomicroscope the aperture closes automatically based on the selected magnification. For unencoded microscopes the aperture must be adjusted manually by the user.



Specimen with a wide-open aperture



Specimen with an optimized aperture

The Different Contrast Methods

Bright field

Bright field is suitable for examining translucent objects featuring contrasting structures. The object is directly illuminated from below and is seen in its natural colors against a bright background.

Operation for bright field illumination is explained starting on page [26](#).



Fly with bright field illumination

Dark Field

For dark field illumination the specimen is lit by two LED elements opposite from each other so that only light that has hit the specimen travels up the beam path of the stereomicroscope. The structure of opaque objects disperses the light, making the object visible against a dark background.

Operation for dark field illumination is explained starting on page [29](#).



Identical subject with dark field illumination

Rottermann contrast

Part of the lighting unit is covered depending on the diaphragm position, which results in contrast effects. Phase structures typically act as spatial, relief-type images – in the positive relief contrast like hills, in the inverted relief contrast like valleys.

Operation for Rottermann contrast is explained starting on page [27](#).



Identical subject with Rottermann contrast

Possible Scenarios



The Leica TL5000 Ergo transmitted light base works together with any device configuration. The base automatically calculates the optimal size of the aperture based on the objective used as well as the user's set magnification. Depending on the configuration used, more or less automation is available for the user.



Leica SmartTouch™

Encoded systems

The stereomicroscope is encoded – this means it can relay information about the optics or magnification being used to the base or a SmartTouch™ control unit. The aperture is automatically adjusted to the respective magnification; if this changes, the aperture adapts to the new situation automatically in order to provide ideal illumination.

Encoded stereomicroscopes:

- *Leica M205 FA*
- *Leica M205 A*
- *Leica M205 C*
- *Leica M165 FC*
- *Leica M165 C*

Unencoded systems

The stereomicroscope is not encoded and cannot relay information about magnification or optics to the base. Control takes place manually, but thanks to intuitive operation the optimal contrast is found quickly. The Leica SmartTouch™ control unit can significantly increase the convenience of using unencoded systems (see page 39).

Unencoded stereomicroscopes:

- *Leica M125*
- *Leica M80*
- *Leica M60*
- *Leica MZ10 F*

Switching the transmitted light base on and off

 The transmitted light base must only be connected to a grounded socket with a faultless power cable! Failure to observe these warnings may result in serious personal injury or even death!

 The LED illumination can be very bright! Check and adjust the intensity of the illumination to a suitable brightness before looking through the eyepieces.

Switching the transmitted light base on and off

1. Switch on the transmitted light base with the power switch on the rear side.



2. Press the on/off switch on the right side once to turn on the illumination.

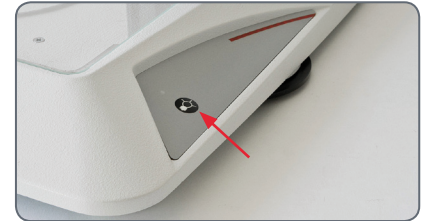

Continued on next page.

Switching the transmitted light base on and off (cont'd)

3. Look through the eyepiece and adjust the light intensity using the control on the right side. The intensity of the illumination is visualized by the LED scale.



4. Press the on/off switch on the right side once again to turn off the illumination on the base.



The following assumes that the power switch on the rear side of the device is always switched on. This switch is not mentioned in the remaining part of this User Manual.



Working with Bright Field Illumination

Bright field illumination

Bright field is suitable for examining translucent objects featuring contrasting structures. The specimen is illuminated directly from below to appear pin-sharp and in natural colors on a bright surface.



Activating bright field illumination

1. Switch on the base as described on page [24](#).
2. Press the "BF" ("Bright Field") button once to activate bright field mode.



 For encoded systems, the aperture closes or opens the illumination aperture corresponding to the magnification selected on the stereomicroscope and the optics being used.

3. Look through the eyepieces and adjust the light intensity using the control on the right side of the base.



Working with Rottermann Contrast

Rottermann contrast

Part of the lighting unit is covered depending on the diaphragm position, which results in contrast effects. Phase structures typically act as spatial, relief-type images – in the positive relief contrast like hills, in the inverted relief contrast like valleys.



Activating Rottermann contrast

1. Switch on the base as described on page [24](#).
2. Press the "RC" ("Rottermann Contrast") button once to activate Rottermann contrast mode and to bring the aperture into position.



 The aperture opens or closes itself corresponding to the magnification selected on the stereomicroscope and the optics being used.

3. Look through the eyepieces and adjust the light intensity using the control on the right side of the base.



Continued on next page.

Working with Rottermann Contrast (cont'd)

Moving the aperture

In order to find the optimum contrast for your specimen use the control on the left side of the base to move the aperture towards the rear or front. While doing so look in the eyepieces until you have found the ideal position.

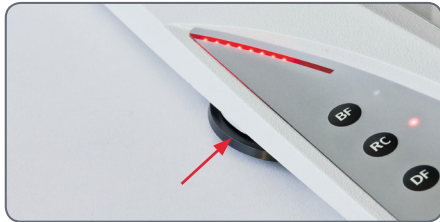

Position of the aperture display

 The current position of the aperture is visualized by an LED strip on the left side of the base. Write down the position of the aperture so that the setting can be reproduced later.

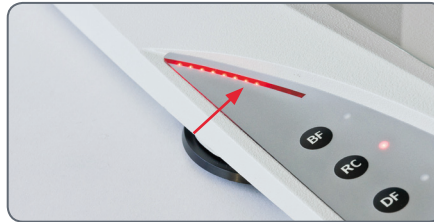

Modifying the opening of the aperture manually

 The automatically set opening of the aperture can be reduced manually if the situation requires.

1. Press and hold the "RC" button and simultaneously select the desired aperture opening using the control on the left side.



Working with Dark Field Illumination

Dark field illumination

For dark field illumination the specimen is lit by two LED elements opposite from each other so that only light that has hit the specimen travels up the beam path of the stereomicroscope. The structure of opaque objects disperses the light, making the object visible against a dark background.

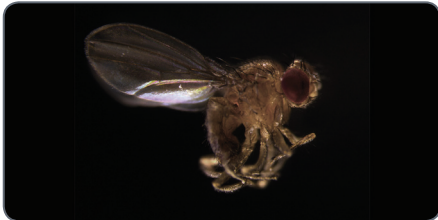

Activating dark field illumination

1. Switch on the base as described on page [24](#).
2. Press the "DF" ("Dark Field") button once to activate dark field mode.



3. Look through the eyepieces and adjust the light intensity using the control on the right side of the base.



4. Change the angle of incidence of the light using the control on the left side of the base in order to find the optimum contrast for your specimen.

Dark Field for Fluorescence Applications

Display with minimal reflections

 If you are be working mainly with dark field illumination, you can remove the protective glass plate from the light source. This way you will have a low-reflection background that will therefore be even darker.

The protective glass plate is located beneath the glass cover of the base, directly above the light source.

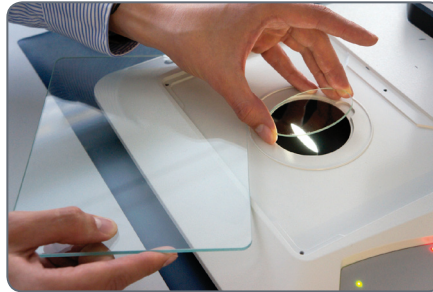

Switching the Automatic Control System for Bright Field On and Off

i If the Leica TL5000 Ergo is used together with an encoded stereomicroscope, the aperture automatically adapts to the selected magnification and the optics being used. This automatic adjustment can be turned off at any time in the bright field "BF" illumination mode.

Deactivating the automatic control system

1. Enable bright field mode ("BF").
2. Press and hold the "BF" button for 2 seconds.



Activating the automatic control system

1. Press the "BF" button again for 2 seconds to reactivate the aperture's automatic control system.

Manual control

i The aperture can be adjusted by the user with the knob on the left side while manual control is active. This will, for example, increase contrast with a reduction in the aperture.



i The size of the aperture is visualized by a curved LED display.

Resetting the Base to Factory Default Settings

Recalling factory settings

The transmitted light base can be returned to its default state – that is, all settings are reset to the value they were upon delivery.

1. Hold the on/off switch on the right side of the base 5 seconds long in order to return to the factory settings.





Preparation for the Automatic Control System

The basics

 Before the automatic contrast of the Leica TL5000 Ergo base can be used, the individual components in the equipment configuration must be detected. This is the only way, for example, that an optimum aperture size can be calculated to eliminate stray light during bright field illumination. The factors that need to be detected are: Objective, visual tube, eyepieces as well as (if present): Camera tube, camera, HC adapter and zoom system accessories (e.g. AX carrier, objective turret, Fluo Combi, coaxial illuminator, A tube, Y tube).

 This one time detection must be carried out before the first time you use the base with the Leica SmartTouch™, Leica Application Suite or Leica Application Suite AF. The configured settings are automatically synchronized between the Leica SmartTouch™ and Leica Application Suite (AF). Redetection is only necessary if the components in the equipment configuration have been changed.

Detection with SmartTouch™

Detection with Leica SmartTouch™

1. Connect the Leica SmartTouch™ control unit to your microscope equipment.
2. On the Leica SmartTouch™, touch the "Config." tab.
3. Touch the "Config." field.
4. In the "Microscope" field select the instrument categories you are using in sequence.
5. In each category, touch the component you are using.

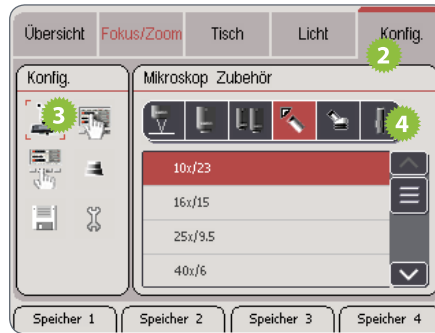

 Detection is complete. Now all of the components of your stereomicroscope are integrated into the automatic aperture control system correctly.

Detection with Leica Application Suite

Detection with Leica Application Suite

1. Start Leica Hardware Configurator.
2. Configure your microscope in Hardware Setup.
3. Start Leica Application Suite.
4. Select the "Configure" command from the main menu.

5. Click the "Microscope" tab.



6. Select the instrument categories you are using in sequence.

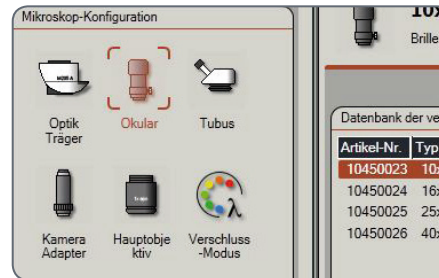

7. In each category, click on the component you are using.

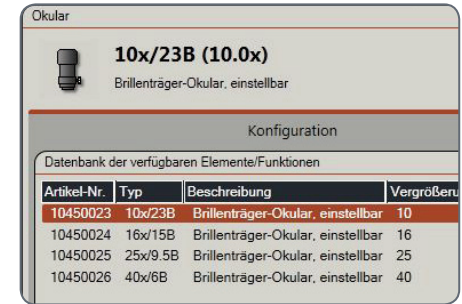

 Detection is complete. Now all of the components of your stereomicroscope are integrated into the automatic aperture control system correctly.

Detection with Leica Application Suite AF

Detection with Leica Application Suite AF

1. Start Leica AF Hardware Configurator.
2. Configure your microscope in Hardware Setup.
3. Click on the "Configure" button.

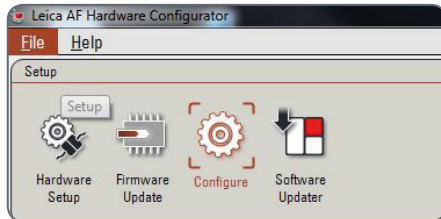

4. Select the instrument categories you are using in sequence.

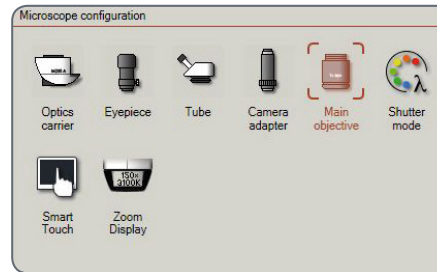

5. In each category, click on the component you are using.

Article no.	Type	Description	Working distance	Diameter
10450027	0.63x	Planapochromatic objective	66.93	80
10450028	1.0x	Planapochromatic objective	61.5	80
10450029	1.6x	Planapochromatic objective	30.5	80
10450030	2.0x	Planapochromatic objective	20.1	85

 Detection is complete. Now all of the components of your stereomicroscope are integrated into the automatic aperture control system correctly.



Operation with Leica SmartTouch™

Leica SmartTouch™ Expands Your Possibilities!

About the Leica SmartTouch™

The Leica SmartTouch™ external control unit makes a variety of tasks easier, combined with an easy-to-understand and well-organized user interface. Control the zoom, focus, and camera. Move the stage with the specimen, restore the test conditions at the touch of a button or change the filter for fluorescence images. All that and much more will be possible with the Leica SmartTouch™.

Controlling the Leica TL5000 Ergo

While interacting with the Leica TL5000 Ergo transmitted light base, the Leica SmartTouch™ controls the intensity of illumination, the contrast method as well as the opening and position of the aperture. But above all, you can save settings and restore them later at the touch of a button. This way you obtain reproducible conditions and consequently have maximum assurance in your experiments.

Additional information

Please consult the manual that was delivered with the Leica SmartTouch™ for information on installation, wiring and start-up.



Leica SmartTouch™

An Overview of the Leica SmartTouch™



Controls on the Touchscreen

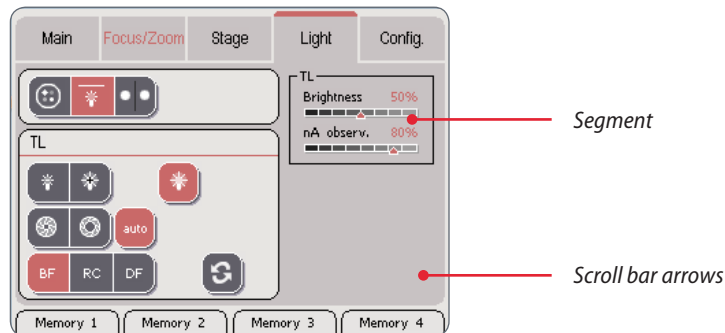
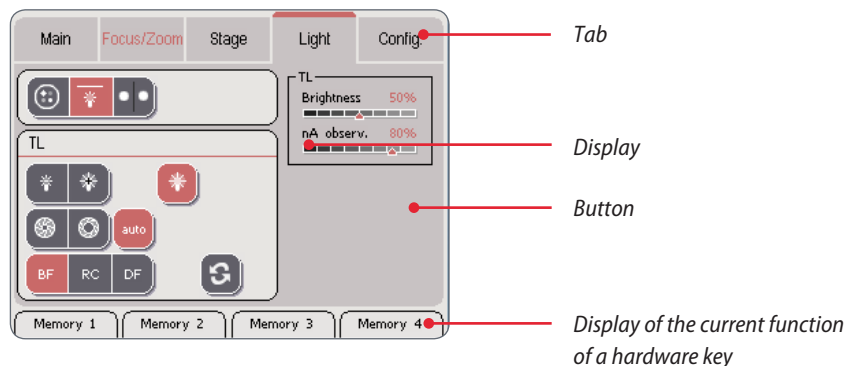

Display conventions

 The display on the display panel only shows the configuration that is actually present. For example, if the motorized mechanical stage is not connected, the corresponding settings are not displayed. The screenshots in this manual may thus differ from the display on your Leica SmartTouch™.

Color coding conventions

 All fixed elements of the user interface (such as labels or titles) are displayed in a black font. All the values that can be modified (such as the zoom factor, status of the illuminator, etc.) are displayed in a red font.

Accessing the Leica TL5000 Ergo

Accessing the Leica TL5000 Ergo

1. Touch the "Light" tab.
2. Touch the symbol for the transmitted light base.
3. Select the desired type of illumination.
4. Put in the desired settings as they are outlined on the following pages.

 The indicator on the display varies depending on the type of illumination selected.

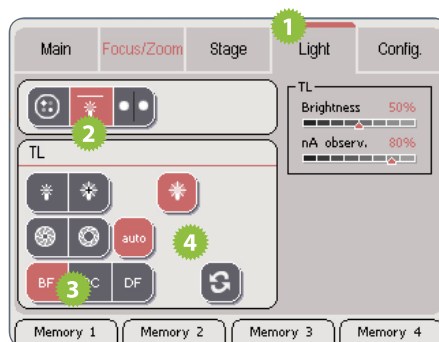

Bright field illumination control system

Bright field illumination control system

1. Touch the "Light" tab.
2. Touch the symbol for the transmitted light base.
3. Touch the "BF" button.
4. Put in the desired settings.

1. Reduce/Increase brightness by tapping repeatedly

2. Manually open or close the base's aperture by tapping repeatedly

3. Switch on/off the aperture's Automatic Control System

4. Select the desired type of illumination

5. Display for the current brightness and aperture settings

6. Switch on/off the base's light source

7. Reset button for restoring the default settings (for all or individual contrast methods)

Rottermann contrast control system

Rottermann contrast control system

 When Rottermann contrast is activated the aperture's opening is limited to only being controlled manually; the "Auto" mode is always active.

1. Touch the "Light" field.
2. Touch the symbol for the transmitted light base.
3. Touch the "RC" button.
4. Put in the desired settings.

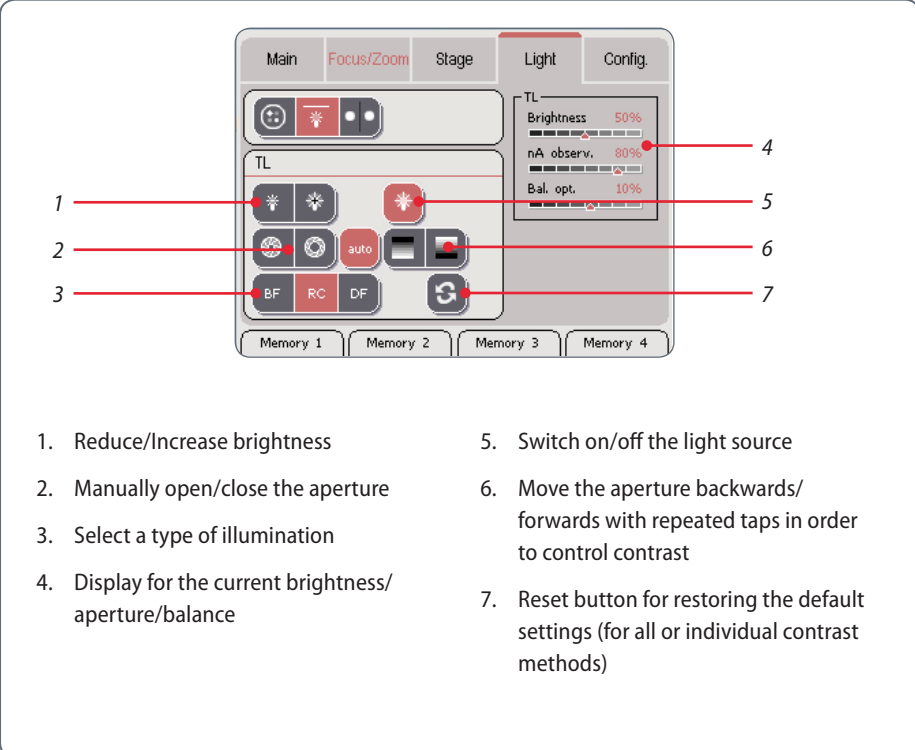

1. Reduce/Increase brightness
2. Manually open/close the aperture
3. Select a type of illumination
4. Display for the current brightness/aperture/balance
5. Switch on/off the light source
6. Move the aperture backwards/ forwards with repeated taps in order to control contrast
7. Reset button for restoring the default settings (for all or individual contrast methods)

Dark field illumination control system

Dark field illumination control system

1. Touch the "Light" tab.
2. Touch the symbol for the transmitted light base.
3. Touch the "DF" button.
4. Put in the desired settings.

The screenshot shows the microscope's control interface with the 'Light' tab selected. The interface includes tabs for 'Main', 'Focus/Zoom', 'Stage', 'Light', and 'Config'. The 'Light' tab contains a 'TL' section with 'Brightness' set to 50% and 'Bal. opt.' set to 10%. Below this are buttons for 'BF', 'RC', 'DF', and a reset button. At the bottom are 'Memory 1' through 'Memory 4' buttons. Red lines connect numbered callouts to the following elements:

- 1: Brightness slider
- 2: Illumination focal point control buttons
- 3: 'DF' button
- 4: 'Bal. opt.' slider
- 5: Light source icon
- 6: Reset button

1. Reduce/Increase brightness
2. Move the illumination focal point backwards/forwards with repeated taps in order to control contrast
3. Select a type of illumination
4. Display for the current brightness/aperture/balance
5. Switch on/off the light source
6. Reset button for restoring the default settings (for all or individual contrast methods)

Switching off the LED display

 The brightness of the LED display can hinder or even prevent observation of light-sensitive specimens and during fluorescence applications. In such cases the display can be shut off through the Leica SmartTouch™.

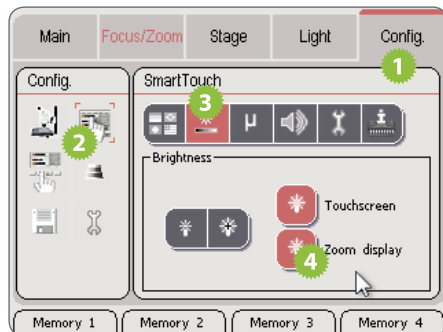

Switching off the LED display

1. Touch the "Config." tab.
2. Touch the "SmartTouch" field in the "Config." field.
3. Touch the "Brightness" symbol.
4. Switch on/off the LED display on the Leica TL5000 Ergo with the "Zoom display" button.

Resetting settings

 The settings on the Leica SmartTouch™ can be reset at any time. This way the standard settings are selectively restored for every or just individual contrast methods.

Resetting settings

1. Touch the symbol for restoring the default settings.

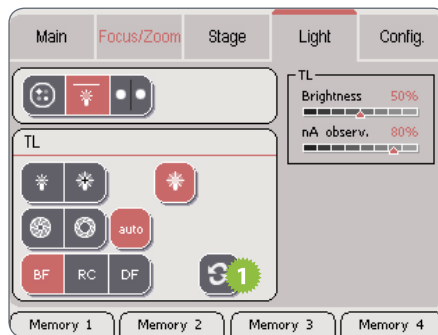

2. Select whether all settings ("All") or only those for the currently active contrast method ("Current") should be reset.

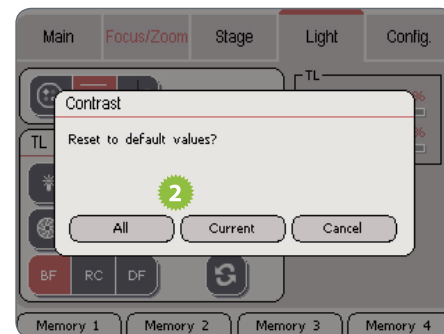

Malfunction Indicator/Automatic Shutoff

Visual note on the base



If an error arises in the base it is indicated on the right side of the base via the blinking of the green LED for the illumination. This is the case, for example, if the LED lighting unit switches itself off due to too high of temperatures. This is due to a safety function designed to prevent damage to the base. As soon as the LED lighting unit has cooled off the base can be used again as usual.



Dimensions and Specifications

Dimensions

Leica M205 C with coarse/fine pinion and Leica TL5000 Ergo transmitted light base

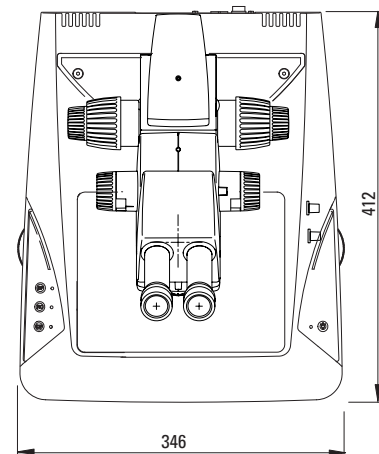
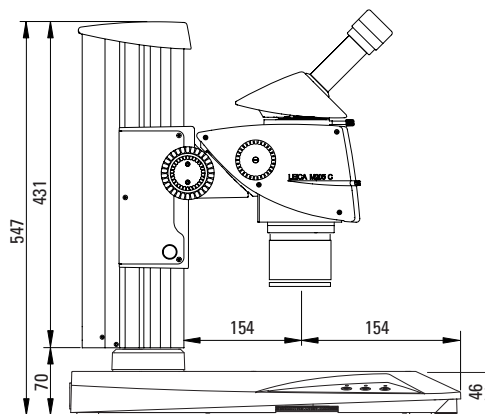
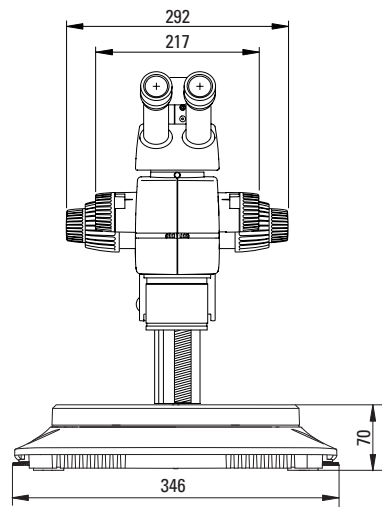

Technical Data

Leica TL5000 Ergo

Light source

Light source	by user
Illuminated area: Bright field Ø	65 mm
Illuminated area: Dark field Ø	40 mm
Relief Contrast System (RC™)	Yes
Internal shutter/lamp control	Yes
Remote control options	Yes
Integrated filter holder	Yes
Matching of high num. aperture	Yes
Anti-Shock™ Pads	Yes
Size (W×H×D, in mm)	412 × 341 × 46

Accessories

IsoPro™ cross-stage support	–
Integrated heating stage (optional)	Yes
Integrated slide adapter (optional)	Yes
ErgoRest™ (optional)	–

Power supply

Input	120–240VAC 47–63 Hz 3.2A
Output	33 VDC 3.93 A 130 W max.

Connections

CAN	3
USB	1
Power Supply	1

Appendix

Care, Maintenance, Contact Persons

We hope you enjoy using your transmitted light base. Leica products are renowned for their robustness and long service life. Observing the following care and cleaning tips will ensure that even after years and decades, your Leica configuration will continue to work as well as it did on the very first day.

Warranty benefits

The warranty covers all faults in materials and manufacture. It does not, however, cover damage resulting from careless or improper handling.

Contact address

However, if your instrument should no longer function properly, contact your technician, your Leica representative or Leica Microsystems (Schweiz) AG, CH-9435 Heerbrugg.

E-mail contact:

stereo.service@leica-microsystems.com

Care

- ▶ Protect your equipment from moisture, fumes and acids and from alkaline, caustic and corrosive materials and keep chemicals away from the instruments.
- ▶ Plugs, optical systems and mechanical parts must not be disassembled or replaced, unless doing so is specifically permitted and described in this manual.
- ▶ Protect your microscope from oil and grease.
- ▶ Do not grease guide surfaces or mechanical parts.

Care, Maintenance, Contact Persons (continued)

Protection from dirt

Dust and dirt will affect the quality of your results.

- ▶ Put a dust cover over the microscope when it will not be used for a long time.
- ▶ Use dust caps to protect tube openings, tubes without eyepieces, and eyepieces.
- ▶ Keep accessories in a dust-free place when not in use.

Cleaning polymer components

Some components are made of polymer or are polymer-coated. They are, therefore, pleasant and convenient to handle. The use of unsuitable cleaning agents and techniques can damage polymers.

Permitted measures

- ▶ Clean the microscope (or parts of it) using warm soapy water, then wipe using distilled water.
- ▶ For stubborn dirt, you can also use ethanol (industrial alcohol) or isopropanol. When doing so, follow the corresponding safety regulations.
- ▶ Remove dust with a pneumatic rubber bulb or with a soft brush.
- ▶ Clean objectives and eyepieces with special optic cleaning cloths and with pure alcohol.